

# SISTEMA ANTISISMICO

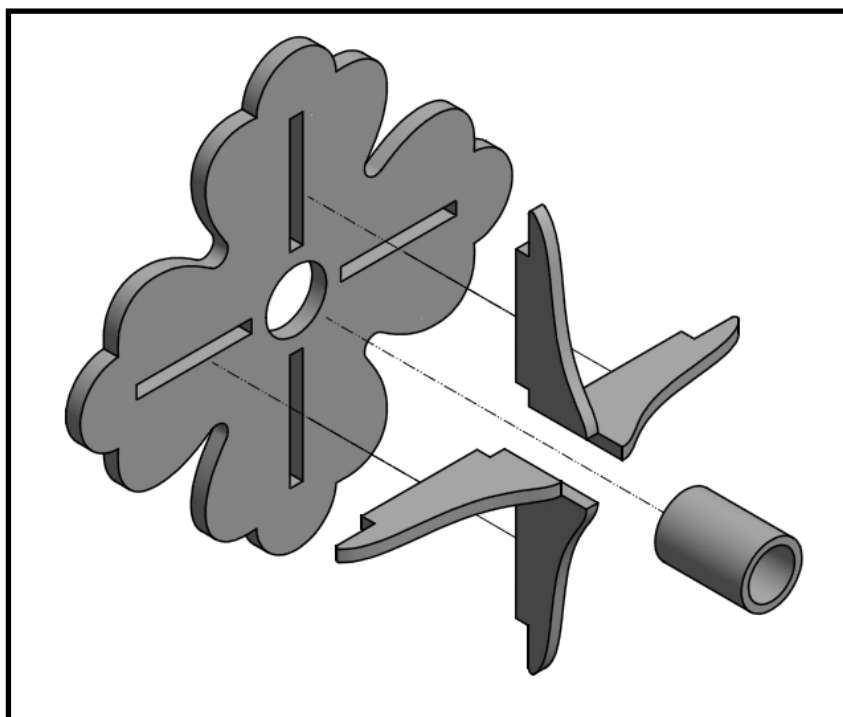
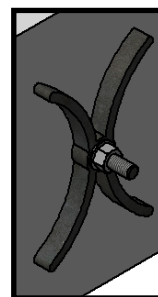
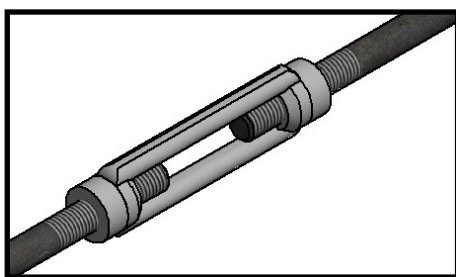
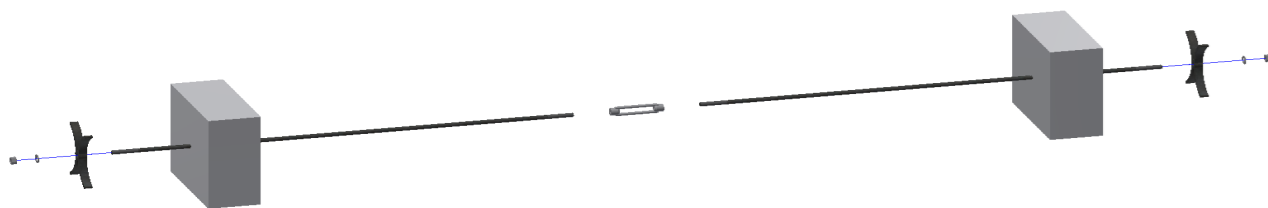

**PROGETTO LASER**

**WWW.PROGETTOLASER.COM - 3342287881**

# PIASTRE IN GHISA



**FB01**

**PIASTRA OVALE 270 X 450**



**FB03**

**PIASTRA OVALE GRANDE 270 X 600**



**FB06**

**PIASTRA TONDA Ø400**



**FB07**

**PIASTRA SMUSSATA 250 X 450**



**FB02**



**PIASTRA QUADRA 300 X 300**



**FB05**

**PIASTRA RETTANGOLARE 300 X 400**

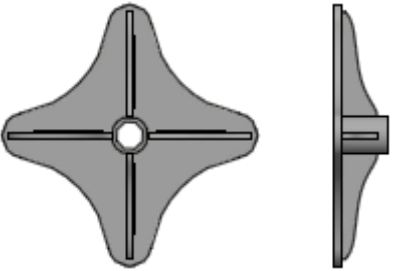
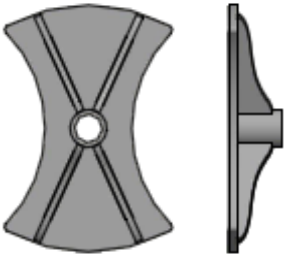
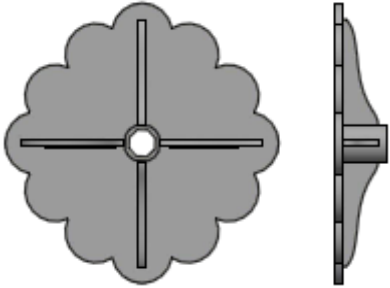
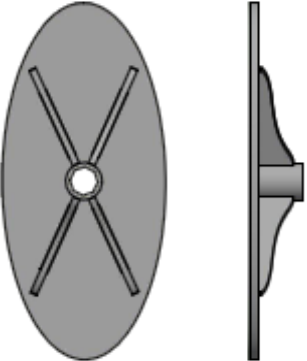
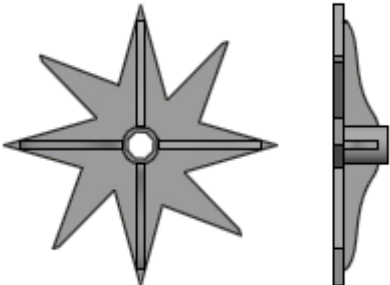
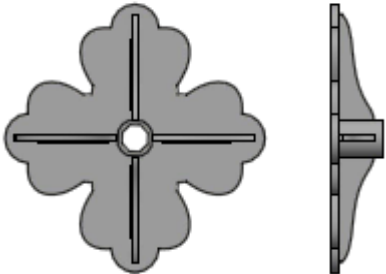
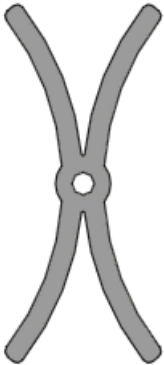
# PIASTRE A DISEGNO E TIRANTI FILETTATI

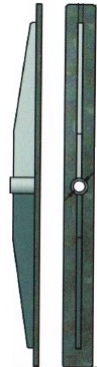
<p><b><u>P1</u></b></p> 	<p><b><u>P2</u></b></p> 	<p><b><u>P3</u></b></p> 
<p><b><u>P4</u></b></p> 	<p><b><u>P5</u></b></p> 	<p><b><u>P6</u></b></p> 
<p><b><u>P7</u></b></p> 	<p><b><u>P8</u></b></p> 	<p><b><u>P9</u></b></p> 



**DOPPIO FILETTO**



Tondo Ø18

Tondo Ø20

Tondo Ø22

Tondo Ø24

Tondo Ø27

Tondo Ø30

**SPECIFICARE FILETTATURA DX/DX O DX/SX  
AL MOMENTO DELL'ORDINE**

# ACCESSORI PER TIRANTI

## TENDITORI

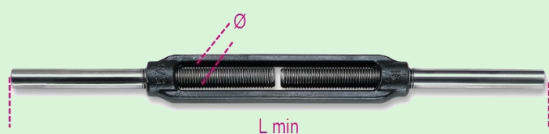

**M18**

**M20**

**M22**

**M24**

**M27**

**M30**

## CANAULIA



**M18**

**M20**

**M22**

**M24**

**M27**

**M30**

## DADI ZINCATI



**M18**

**M20**

**M22**

**M24**

**M27**

**M30**

## RONDELLE ZINC.

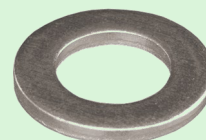

**M18**

**M20**

**M22**

**M24**

**M27**

**M30**